

The  
**What is a Mine?**  
Colouring Book

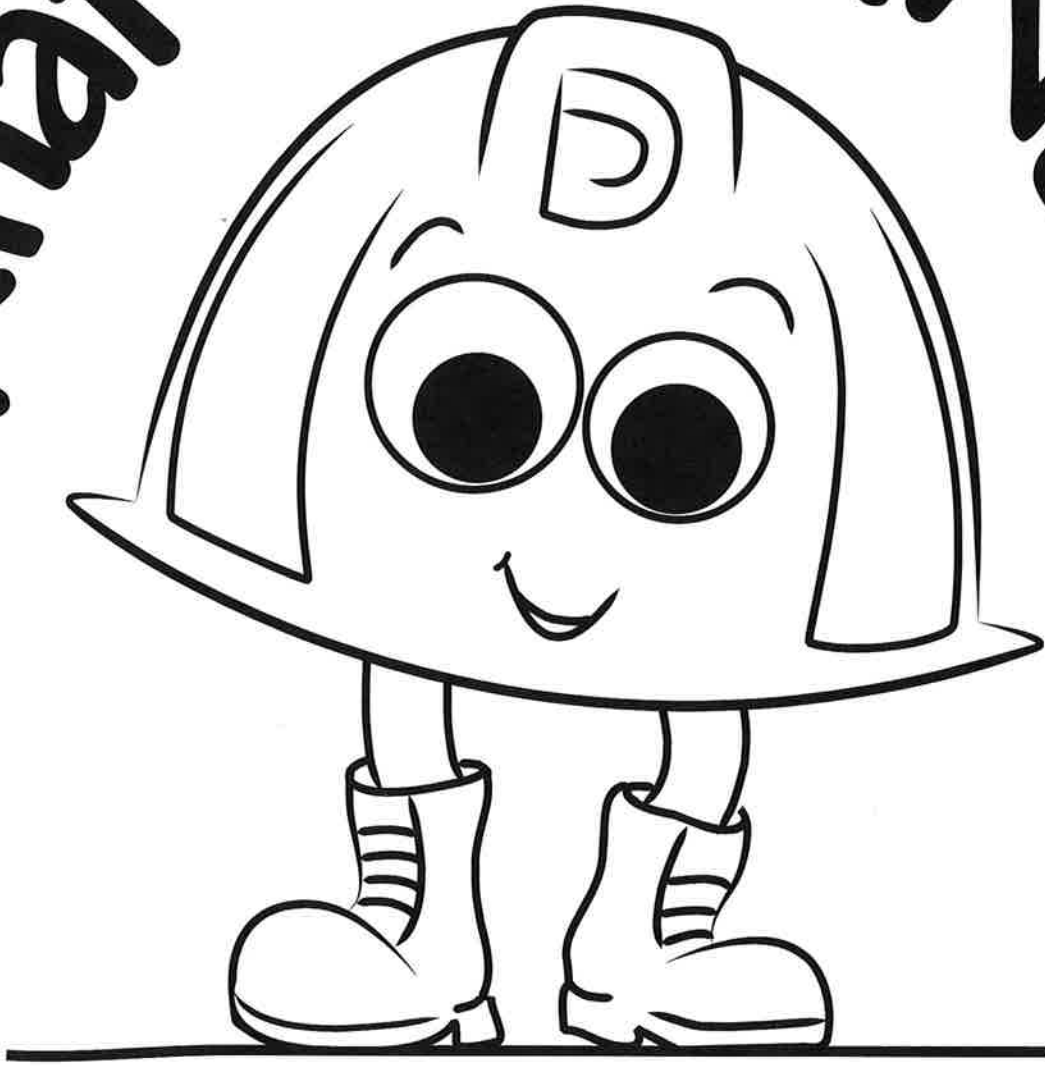

What is a Mine?



Hello, my name is P.D. and I am going to take you on an adventure that will help you answer the question, "What is a Mine?" LET'S GO!

 PLACER DOME INC.

Minerals were formed millions of years ago when the Earth's crust went through many changes.

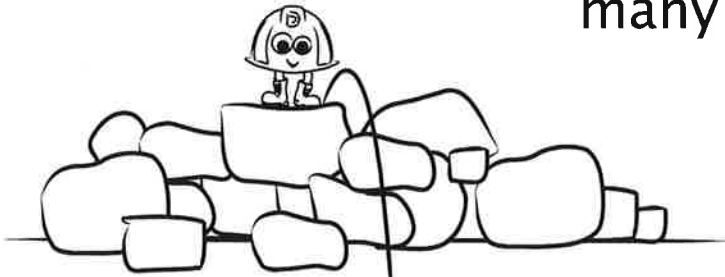

Minerals are used to make many things including jewellery, cars, electronics and much more.

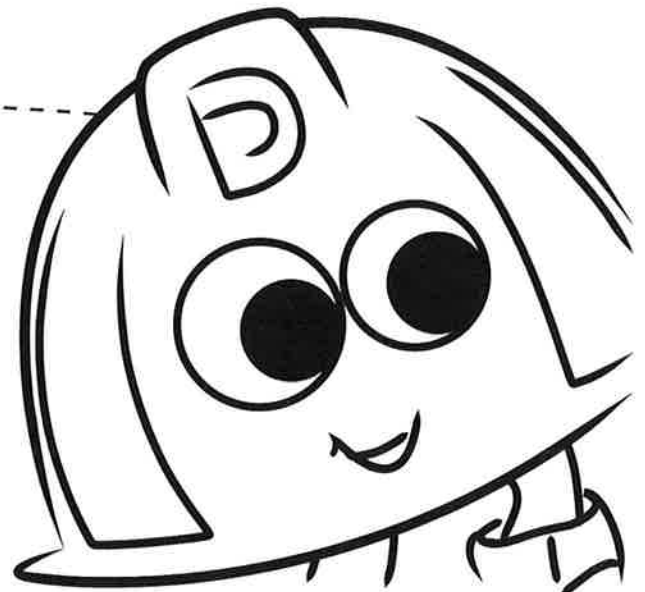
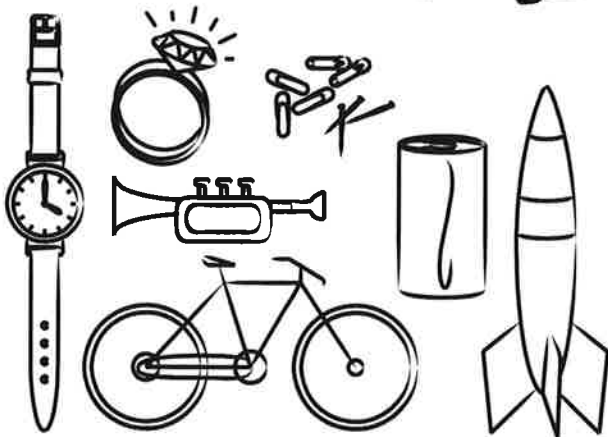
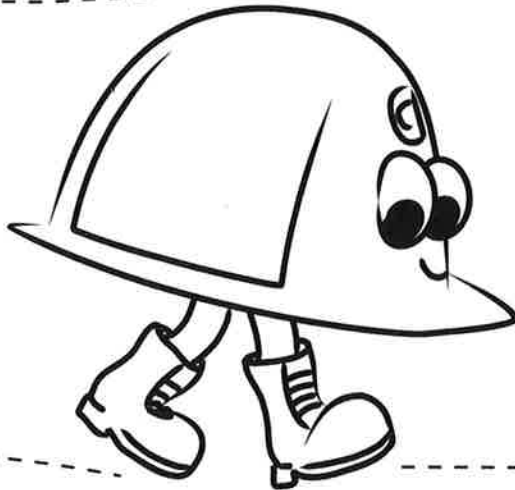
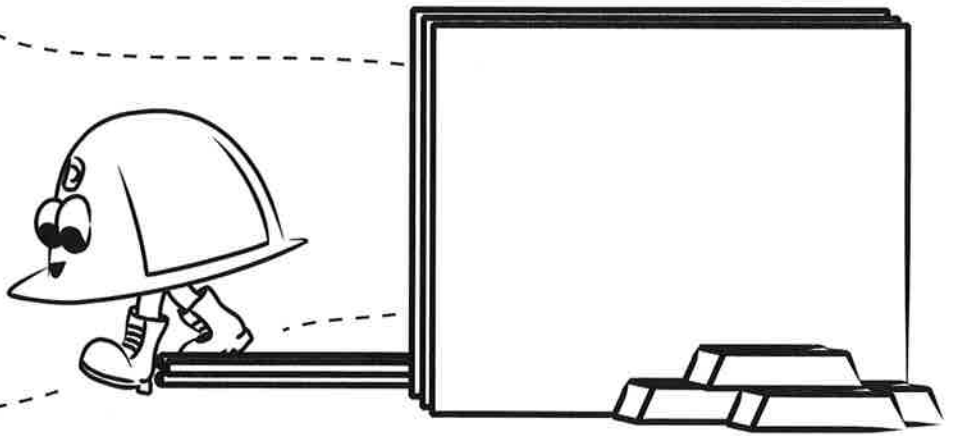

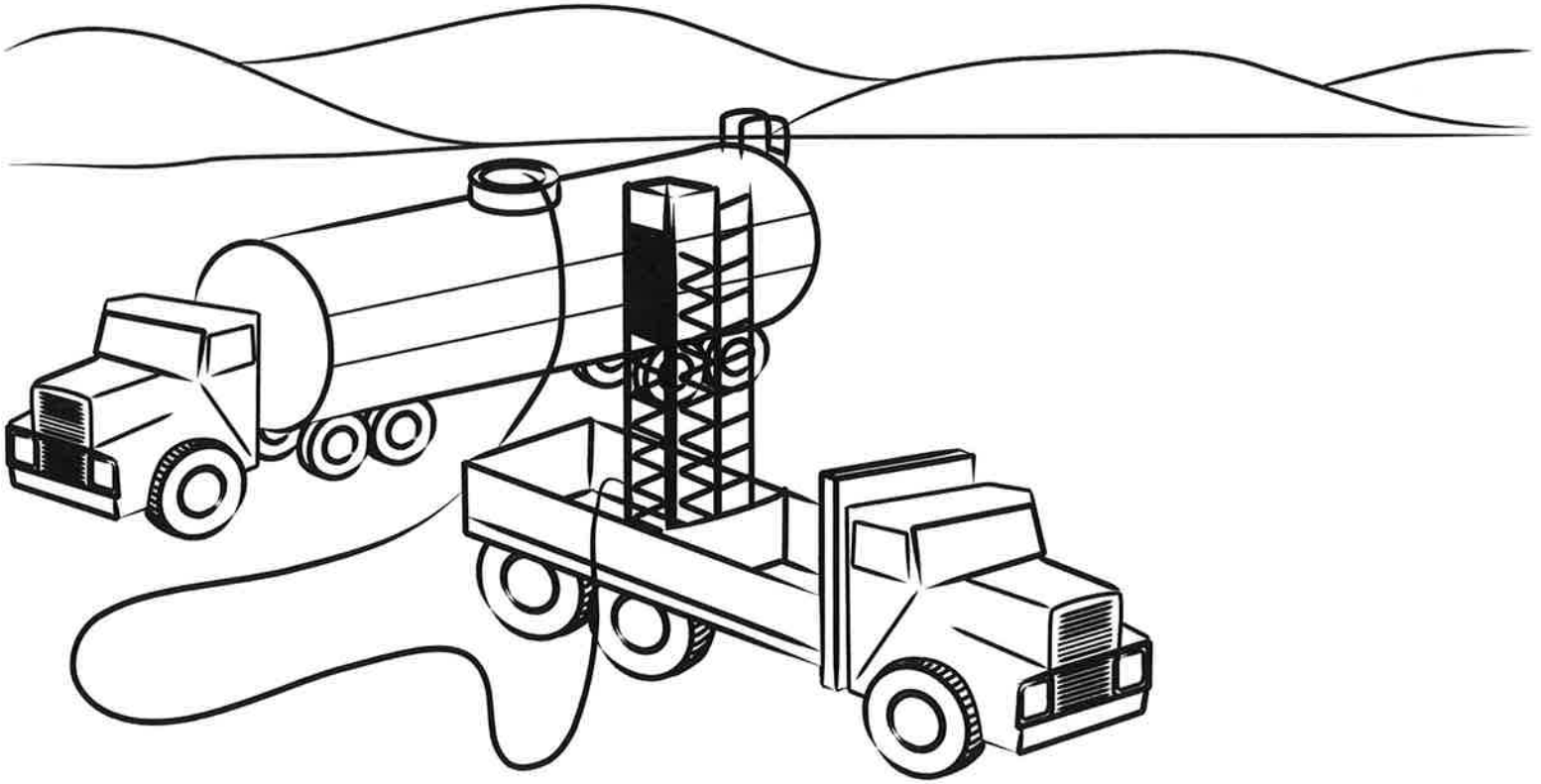

Before mining can begin, we need to know where the minerals are located underneath the earth's surface.

The people who study rocks and minerals are called geologists. Geologists rely on drills to reach minerals underneath the earth's surface. Once geologists find minerals, a sample is taken from the earth. This sample is brought to the laboratory where it is tested.

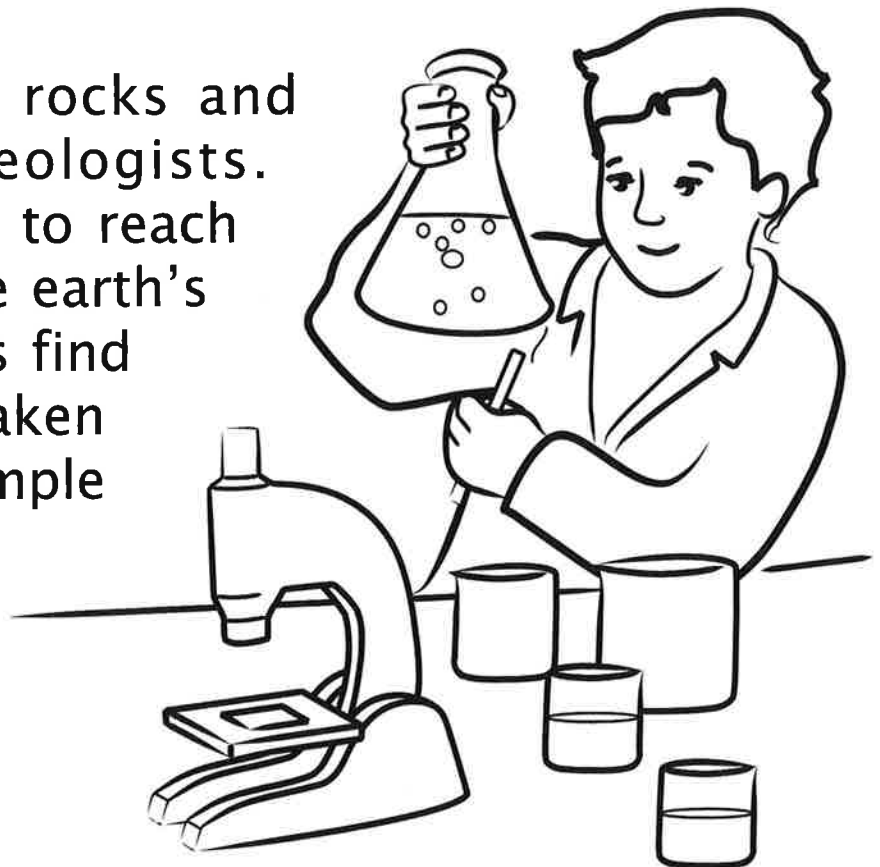

Once a company decides to build a mine, many things need to be decided and organized. Geologists, engineers and many other specialists are all involved in this stage of the mining process.



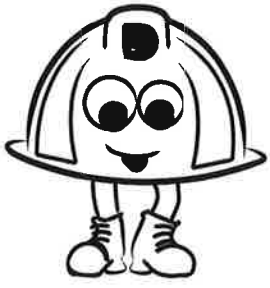

Hundreds of people are needed to build a mine. The construction of a mine includes building offices and repair shops, as well as the areas where the ore is dug out of the ground.



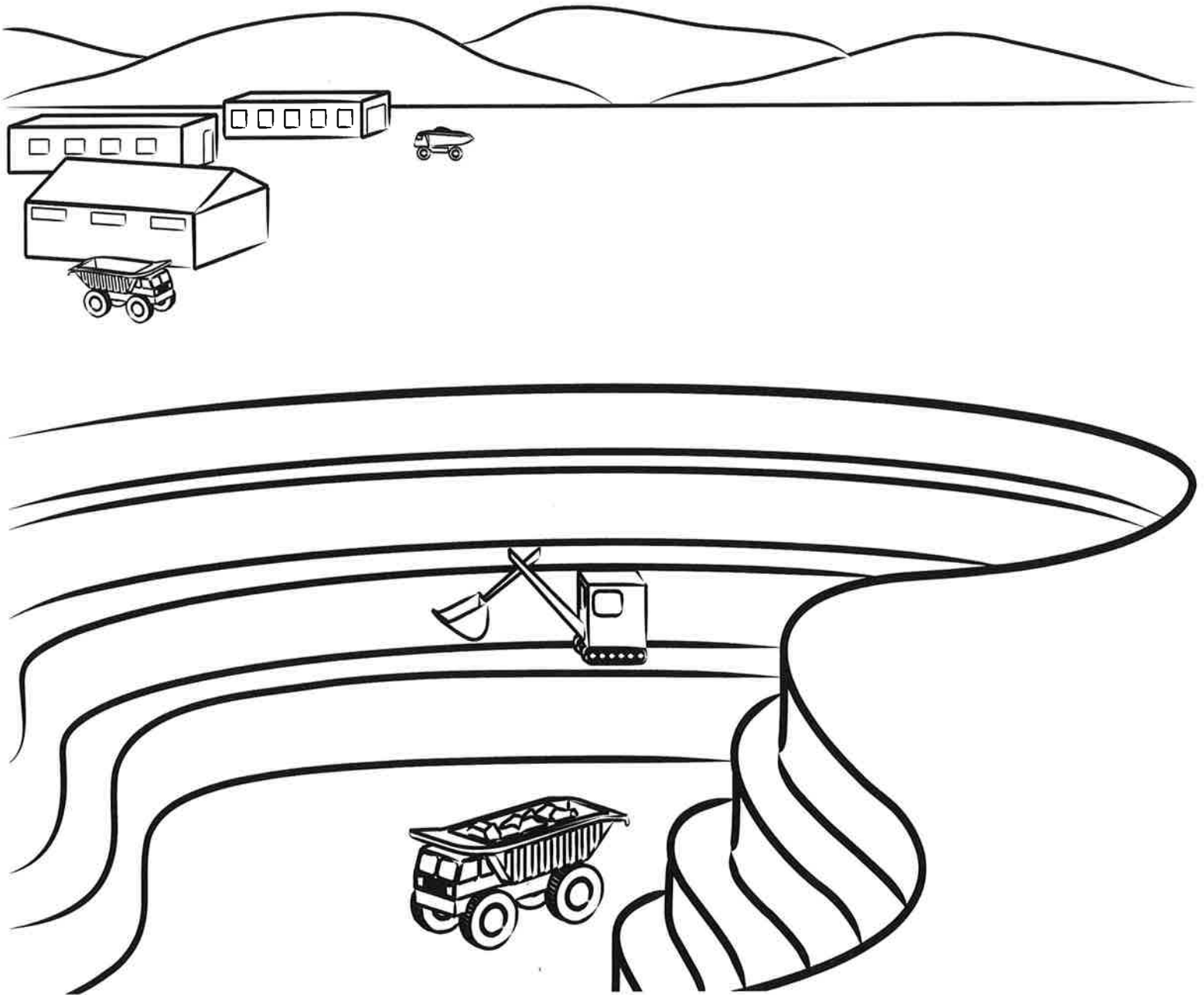

Mines that look like the one here are called open pit or surface mines. Rocks and minerals are dug out from the surface at these mines.

This type of mine is called an underground mine. When valuable rock or mineral deposits are located far beneath the earth's surface, underground mines are necessary.

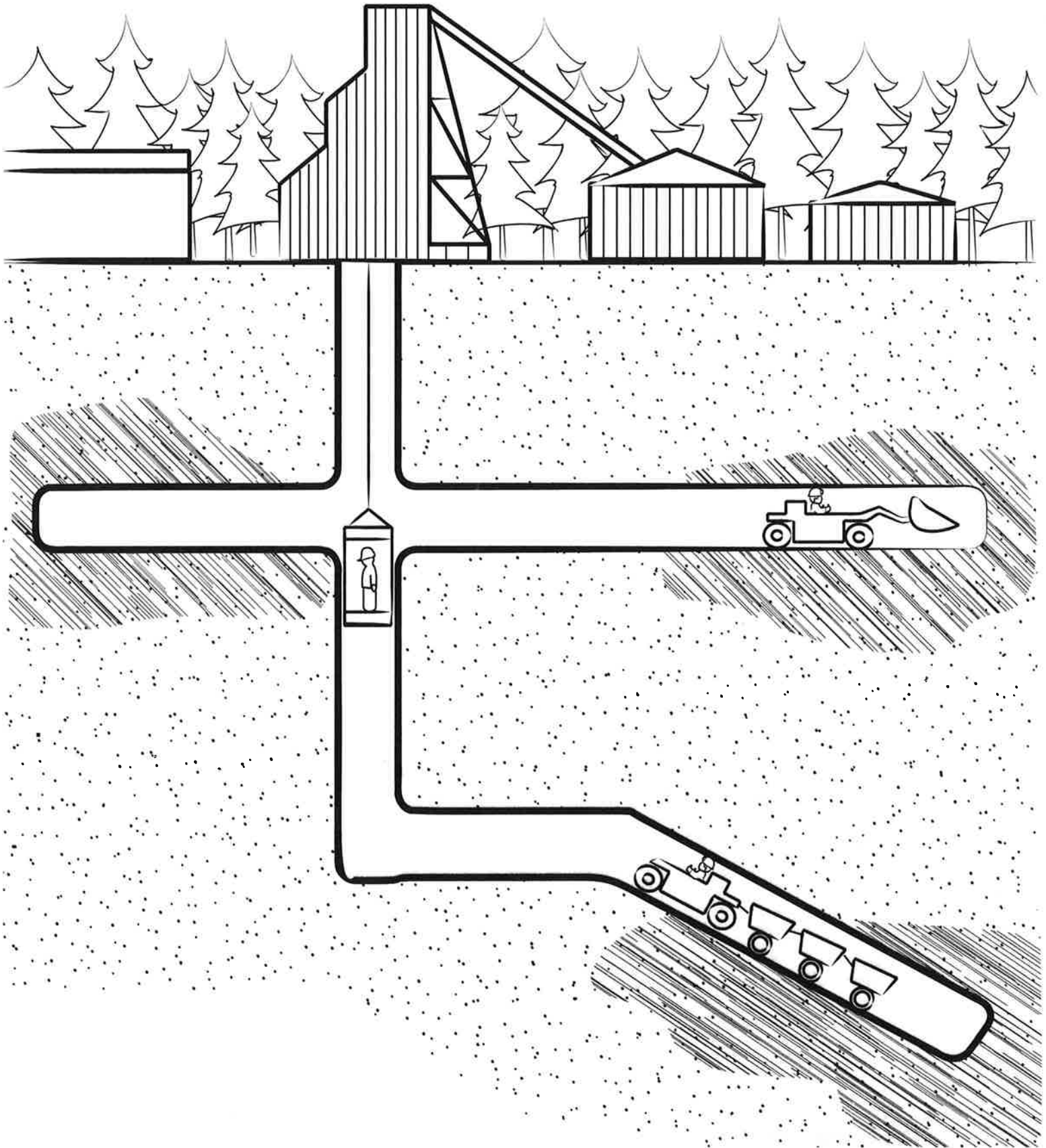



Once the mine is built, we can start to take minerals out of the earth. At an underground mine, the first step is to blast tunnels. These tunnels are called stopes.

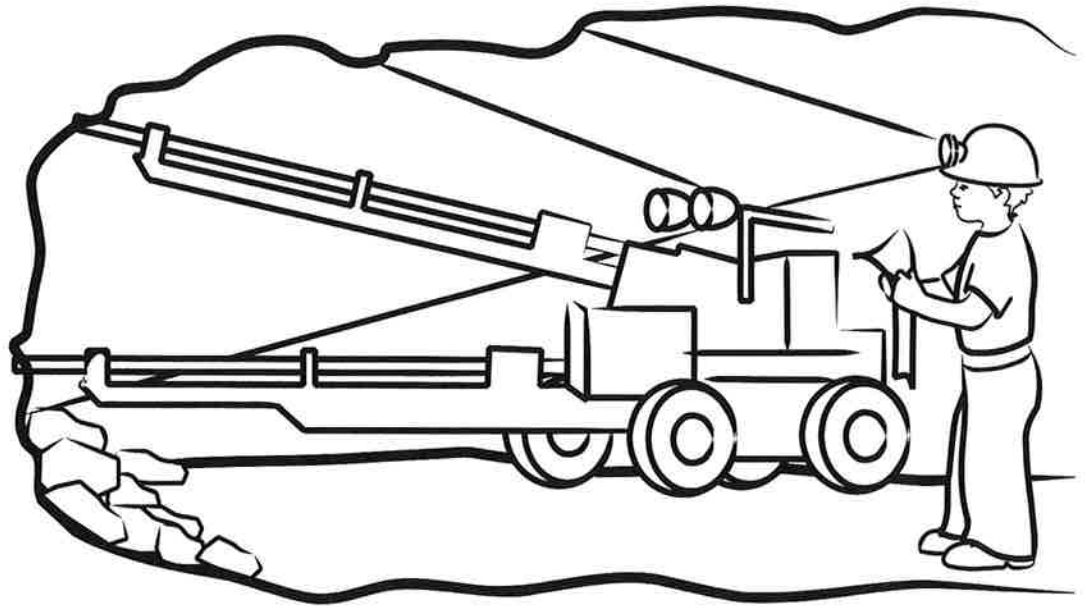

After blasting, loose rocks are scooped up by machines and brought to the surface in an elevator called a skip.

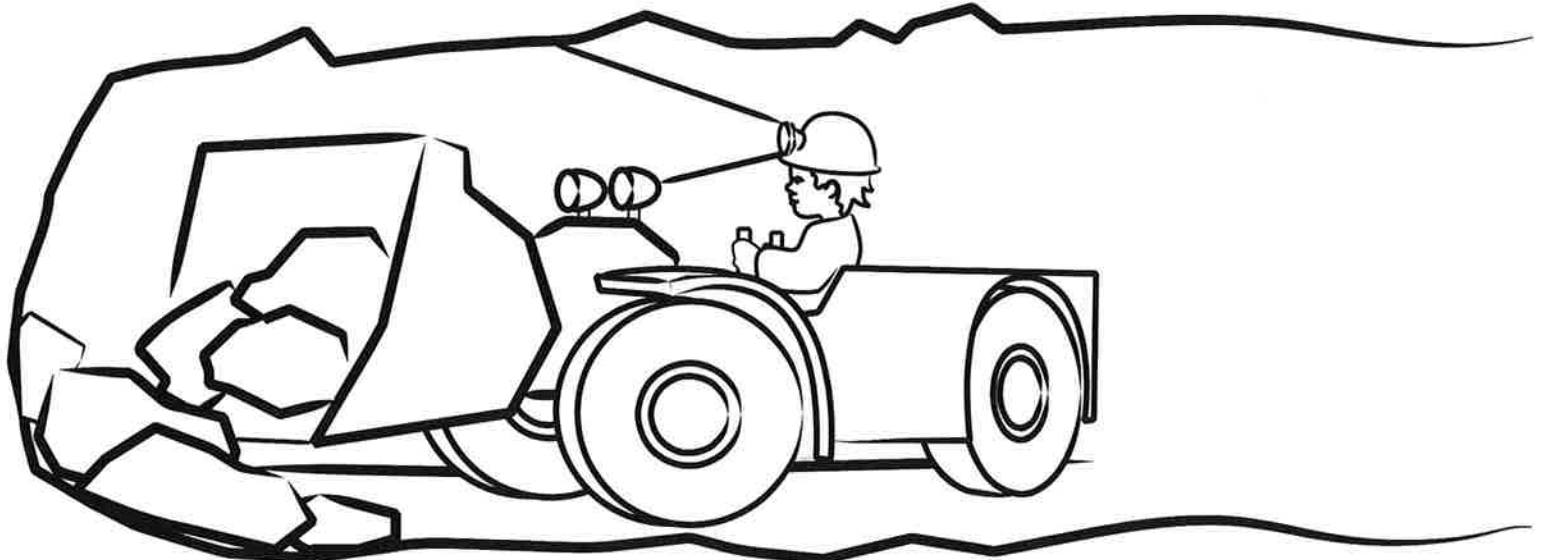

Once the rocks are removed from the earth, they are transported by truck, or sometimes by conveyor belt, to a crushing machine where the rocks are made smaller and smaller until they become a powder.

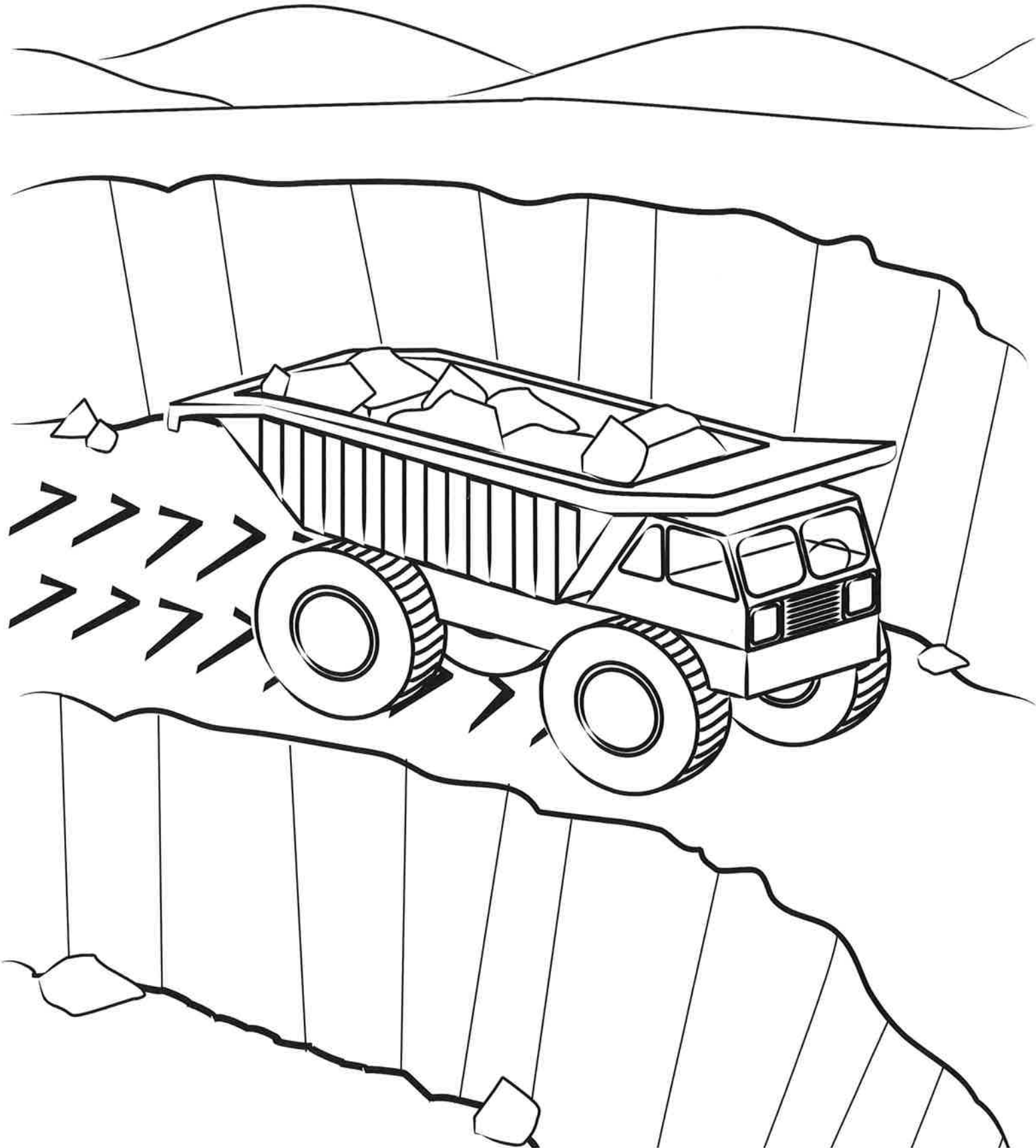

After the rocks have been crushed, the minerals still need to be separated from the powder. The powder is put into large tanks of water and chemicals where air is bubbled through the mixture until the minerals

have separated from the powder. This is a chemical process called leaching.

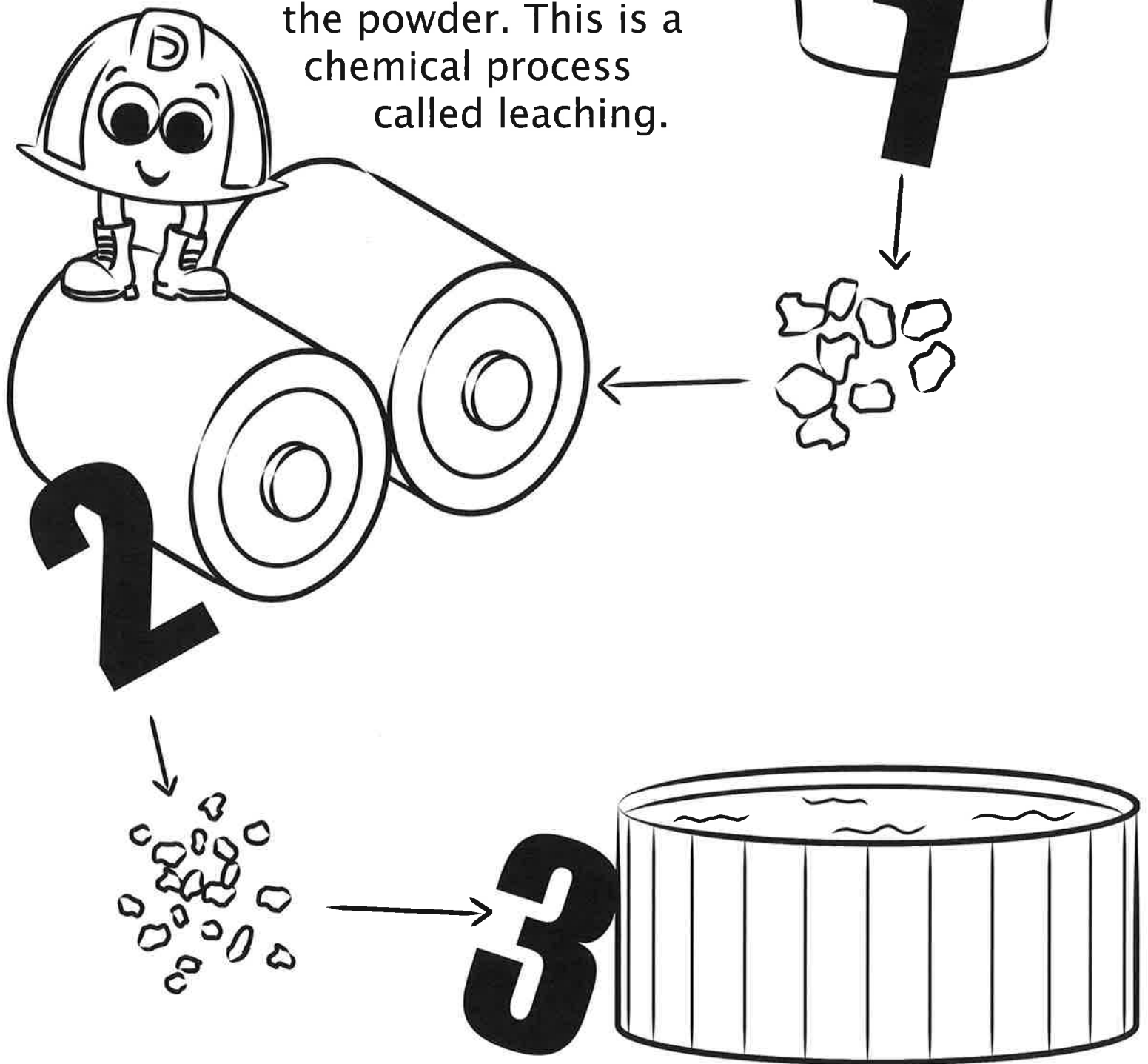

The minerals are then placed into a big furnace where they are melted. Once the minerals are melted, they are poured into moulds where they cool and harden into bars. These bars are worth lots of money, especially if the mineral is gold!

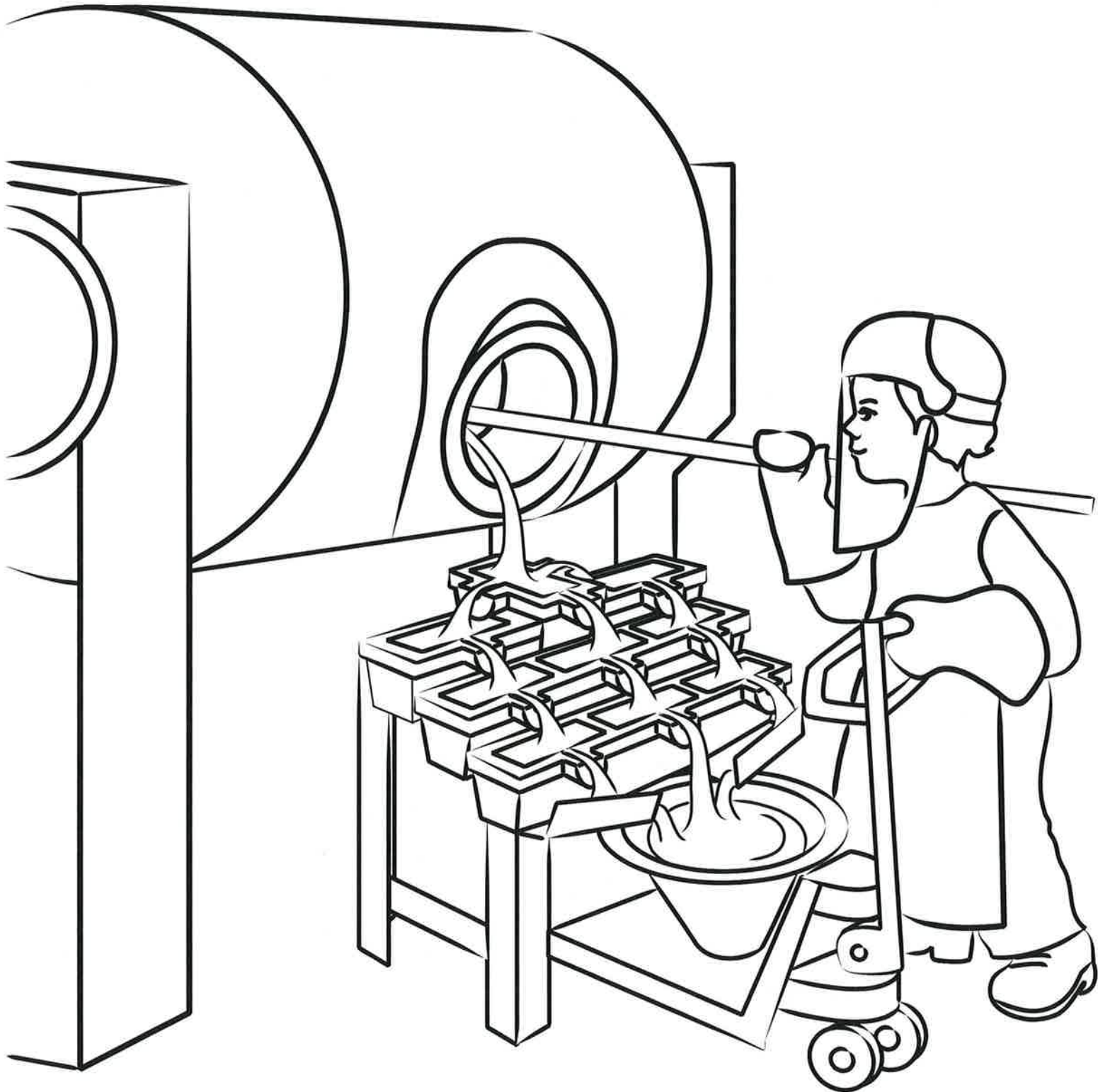

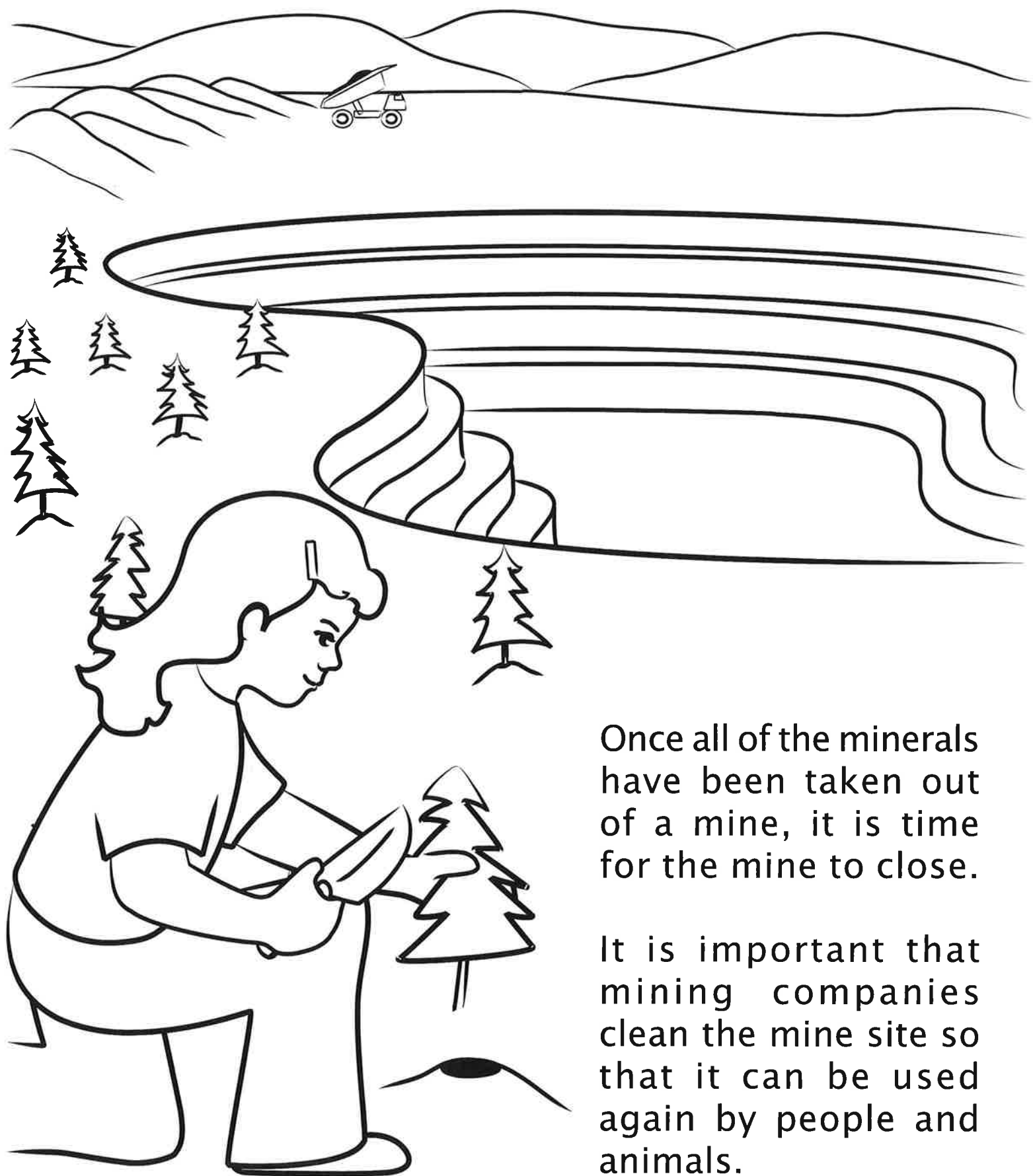

Once all of the minerals have been taken out of a mine, it is time for the mine to close.

It is important that mining companies clean the mine site so that it can be used again by people and animals.

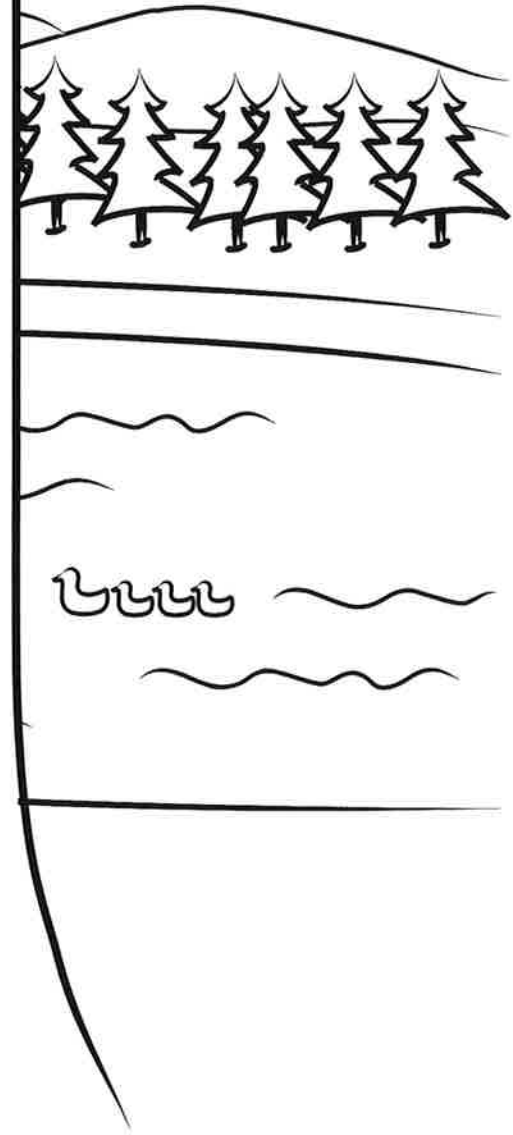
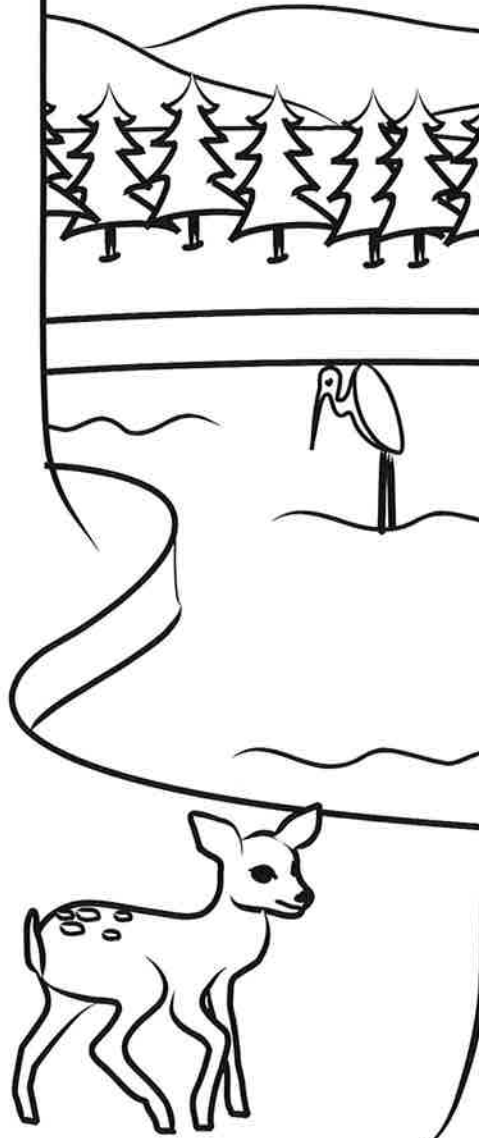

Mining companies fertilize the soil and plant grass and trees to return the mine site to its natural condition.

This is called reclamation.



Now that you know more about minerals and mining, try to find all the things in this picture that were made using minerals.

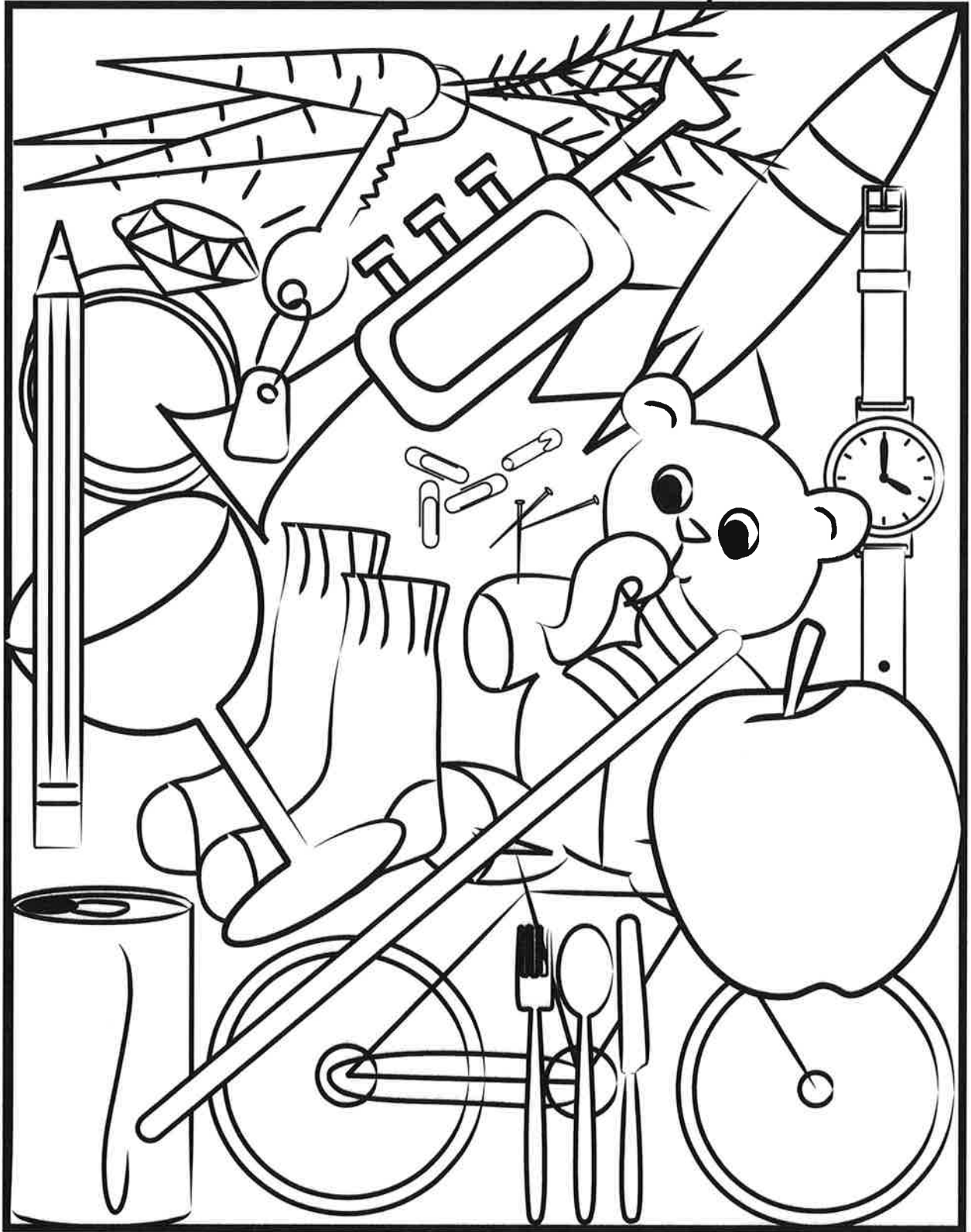

Can you help P.D.  
find his way out of  
the underground  
mine maze?

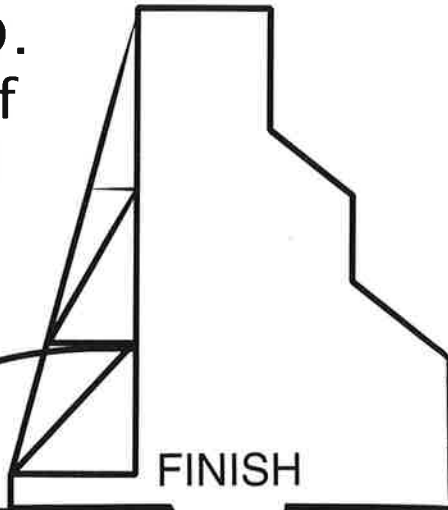

FINISH

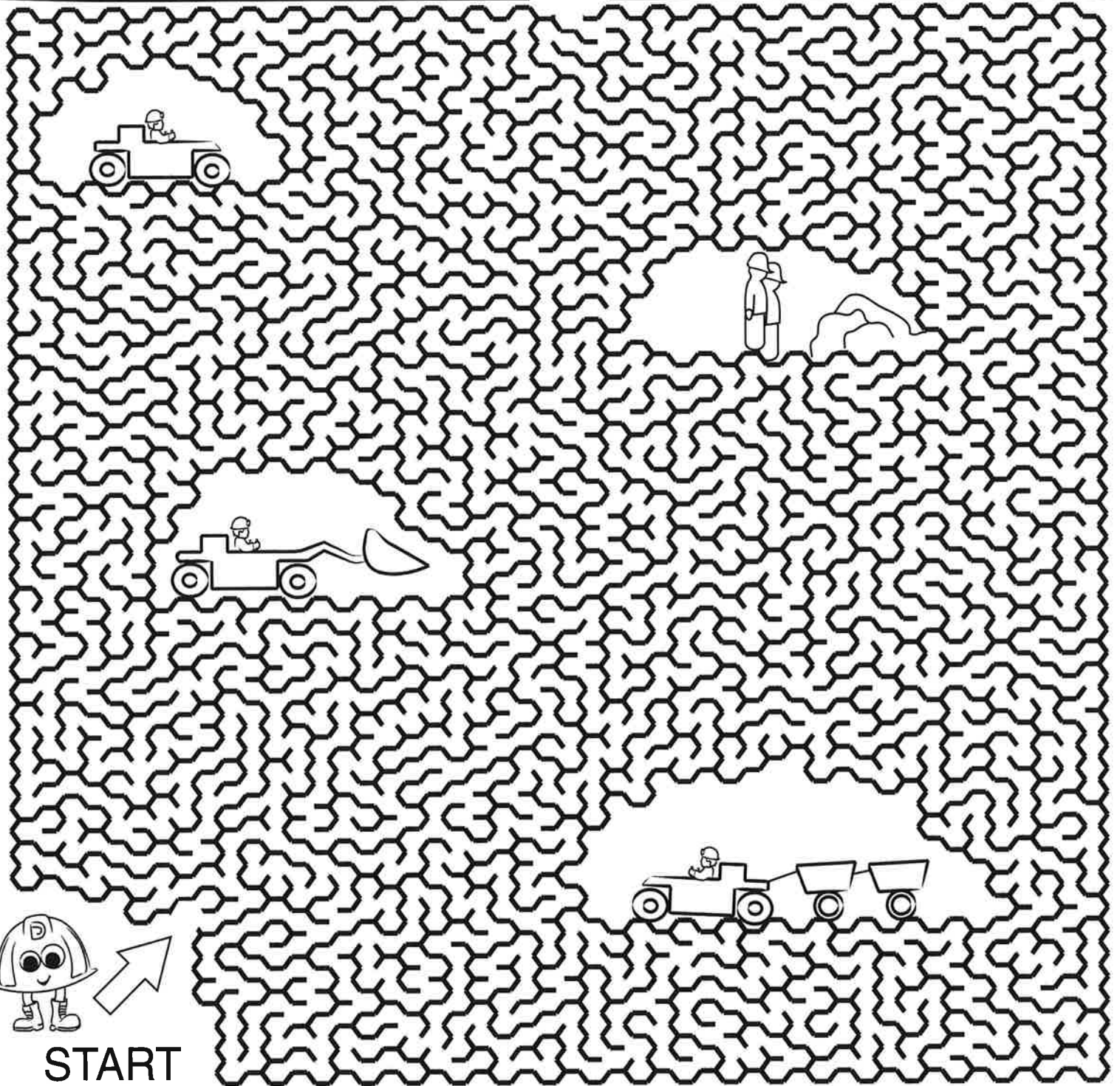

START



# WORD SEARCH

CAN YOU FIND THE LOST WORDS?

Y F M Y Q Z U F C L C L Q L V  
D D W N D Z S U W B B E C D J  
U V S Y O E Z T U L I A F G L  
B N O Y W L J H Z A Q C R G Q  
W B A A D R N G E R U H E U C  
A H G T I P B Q I E N I E A G  
Y W S G S L L T H N G N C S S  
F S X D C R U S H I N G A O Y  
F W G D O Z Q I N M F C F T A  
J E I L V E N G I N E E R B C  
M G F R E P P O C W Q E U G Z  
N L S N R J T L F W G H S U G  
T C T Z X S P O H P O G U B Z  
J M Z M A A V E O P L R U W C  
Y Y D N U O R G R E D N U K L

COPPER  
CRUSHING  
DISCOVER  
ENGINEER  
GEOLOGIST  
GOLD

LEACHING  
MINE  
MINERAL  
PIT  
SURFACE  
UNDERGROUND

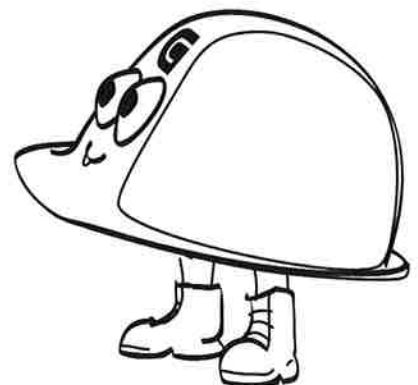

# CONNECT THE DOTS

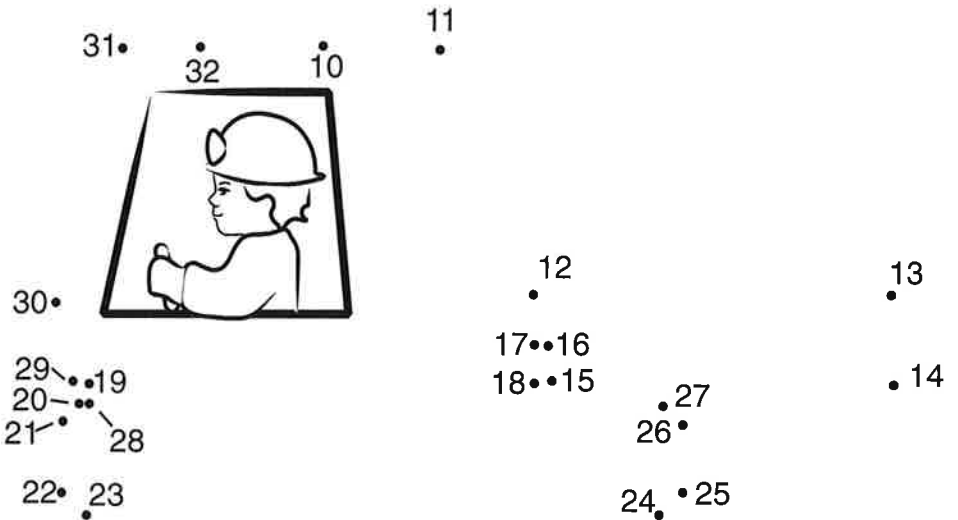
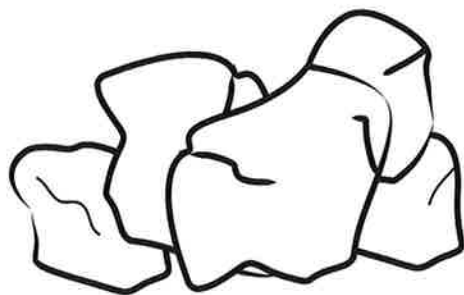
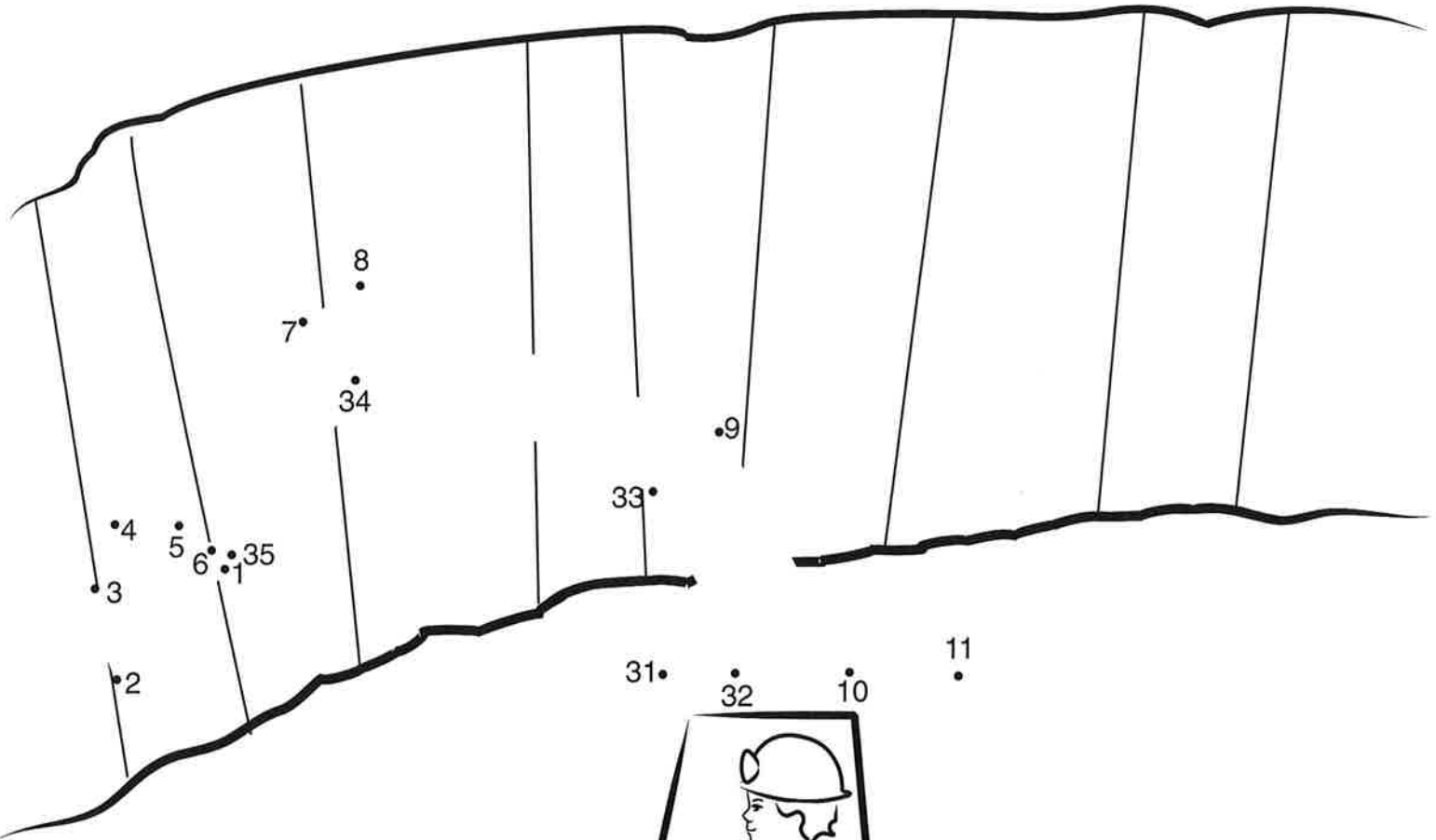
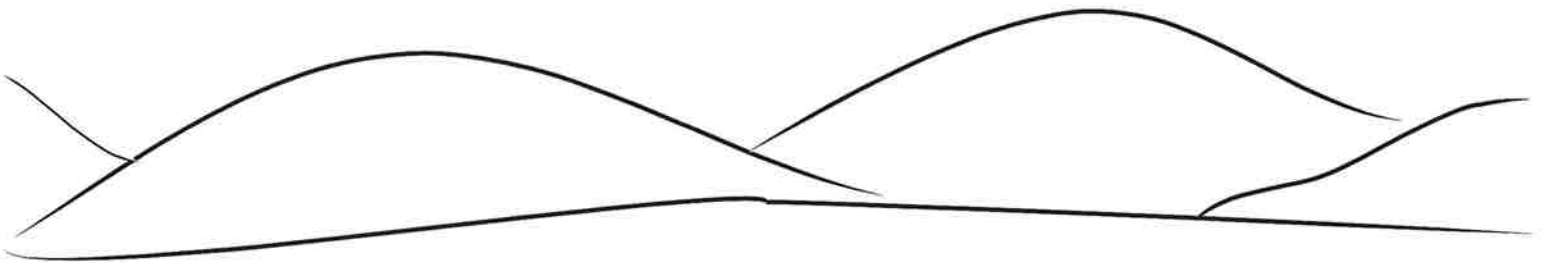

It takes many different kinds of people to make mining possible. At Placer Dome, these people come from a variety of countries and work at mines all over the world.

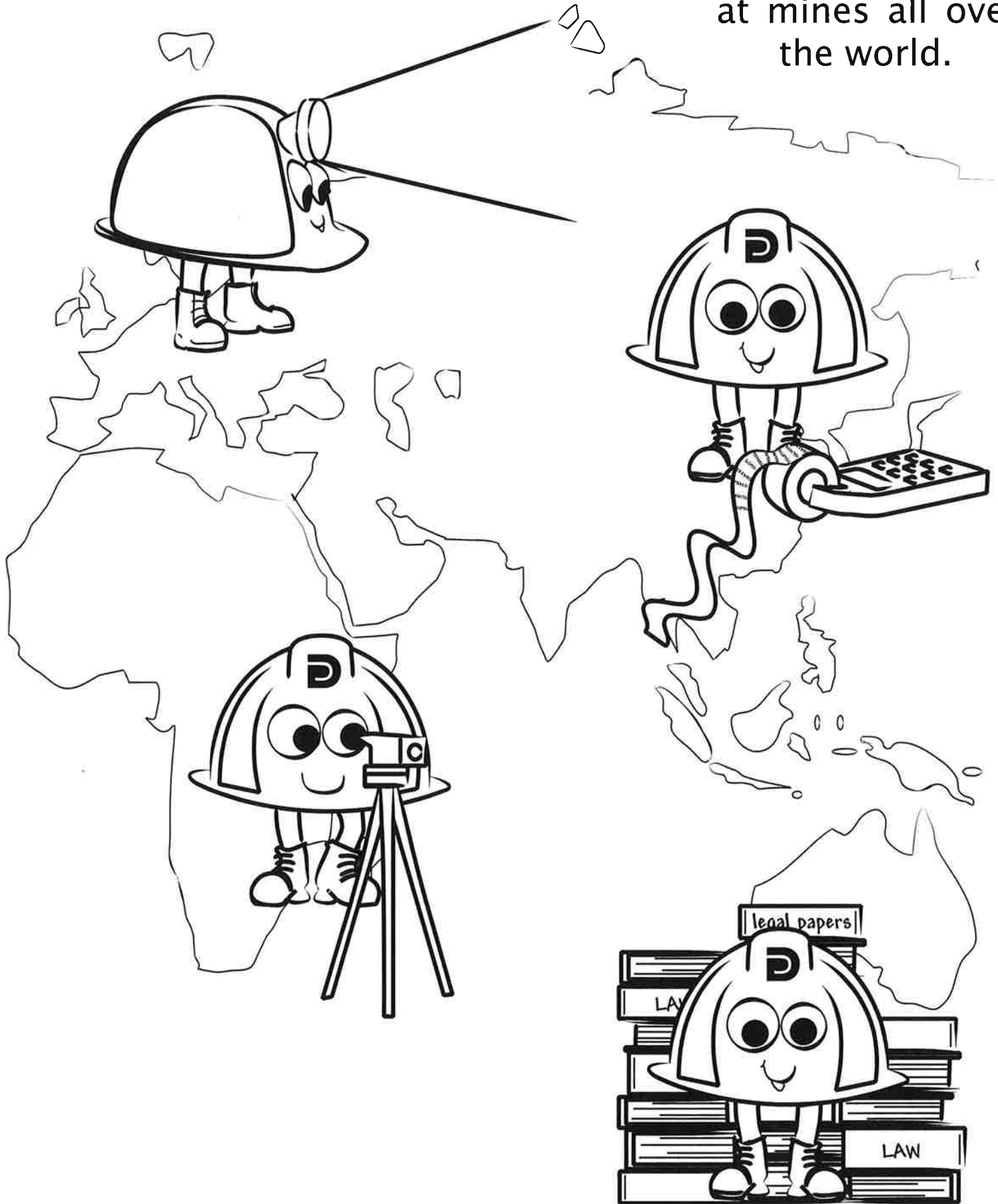



Placer Dome is a global mining company that specializes in gold mining. We have mine sites around the world and our head office is located in Vancouver, Canada.

Our tour of the mining process is over and it's time for me to say goodbye. I hope I have helped you answer the question "What is a Mine?" and that you are now familiar with minerals and the role they play in our everyday lives.

**BYE FOR NOW!**

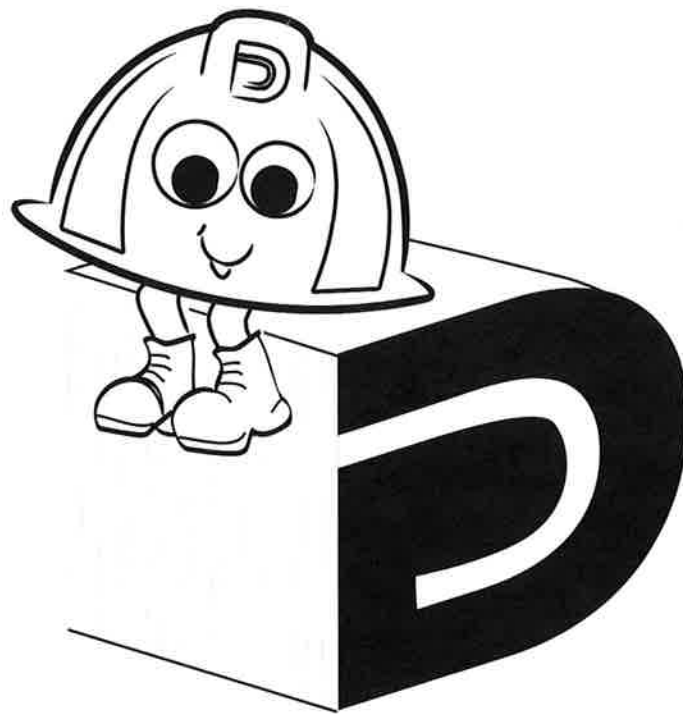



Compliments of Placer Dome